

TiWi-uB1 *Bluetooth Smart* (BLE) Module

FEATURES

- Built in CC2541 single-chip *Bluetooth Smart* (BLE 4.0) System-On-Chip (SOC).
- Memory: 256kB FLASH, 8kB RAM
- RF Output Power: 0 dBm (Class 3)
- RF Receive Sensitivity: -94 dBm
- Size: 11.6mm x 17.9 mm x 2.3 mm
- Operating Voltage: 2.0V to 3.6V
- Operating Temperature: -40 to +85° C
- Worldwide Acceptance: FCC (USA), IC (Canada), ETSI (Europe), Giteki (Japan)
- REACH and RoHS compliant
- Complete power-optimized stack, including Controller and Host
 - GAP – Central, Peripheral, Observer, or Broadcaster (Including Combination Roles)
 - ATT/GATT – Client and Server
 - SMP – AES-128 Encryption and Decryption
 - L2CAP
- Multiple Configuration Options
 - Single-Chip Configuration, Allowing Applications to Run on CC2541
 - Network Processor Interface for Applications Running on an External Microcontroller

APPLICATIONS

- 2.4 GHz *Bluetooth* Low Energy Systems
- Human-Interface Devices (Keyboard, Mouse, Remote Control)
- Sports and Leisure Equipment
- Mobile Phone Accessories
- Consumer Electronics

DESCRIPTION

LSR would like to announce a low-cost and low-power consumption module which has all of the *BluetoothSmart* functionalities.



The TiWi-uB1 module fully supports the single mode *Bluetooth* Low Energy operation, and the output power can support class 3. The module provides the ability to either put your entire application into the integrated 8051 microcontroller, or use the module in Network Processor mode in conjunction with the microcontroller of your choice.

Need to get to market quickly? Not an expert in *Bluetooth* Low Energy? Need a custom antenna? Do you need help with your host board? LSR Design Services will be happy to develop custom hardware or software, or help integrate the design. Contact us at sales@lsr.com or call us at 262-375-4400.

ORDERING INFORMATION

Order Number	Description
450-0103C	TiWi-uB1 Module, PCB Trace Antenna (Cut Tape)
450-0103R	TiWi-uB1 Module, PCB Trace Antenna (Tape & Reel)
450-0106C	TiWi-uB1 Module, External Antenna Port (Cut Tape)
450-0106R	TiWi-uB1 Module, External Antenna Port (Tape & Reel)
450-0120	TiWi-uB1 EM Board, PCB Trace Antenna

Table 1 Orderable Model Numbers

MODULE ACCESSORIES



	Order Number	Description
	001-0001	2.4 GHz Dipole Antenna with Reverse Polarity SMA Connector
	080-0001	U.FL to Reverse Polarity SMA Bulkhead Cable 105mm

Table 2 Module Accessories

The information in this document is subject to change without notice.

BLOCK DIAGRAM

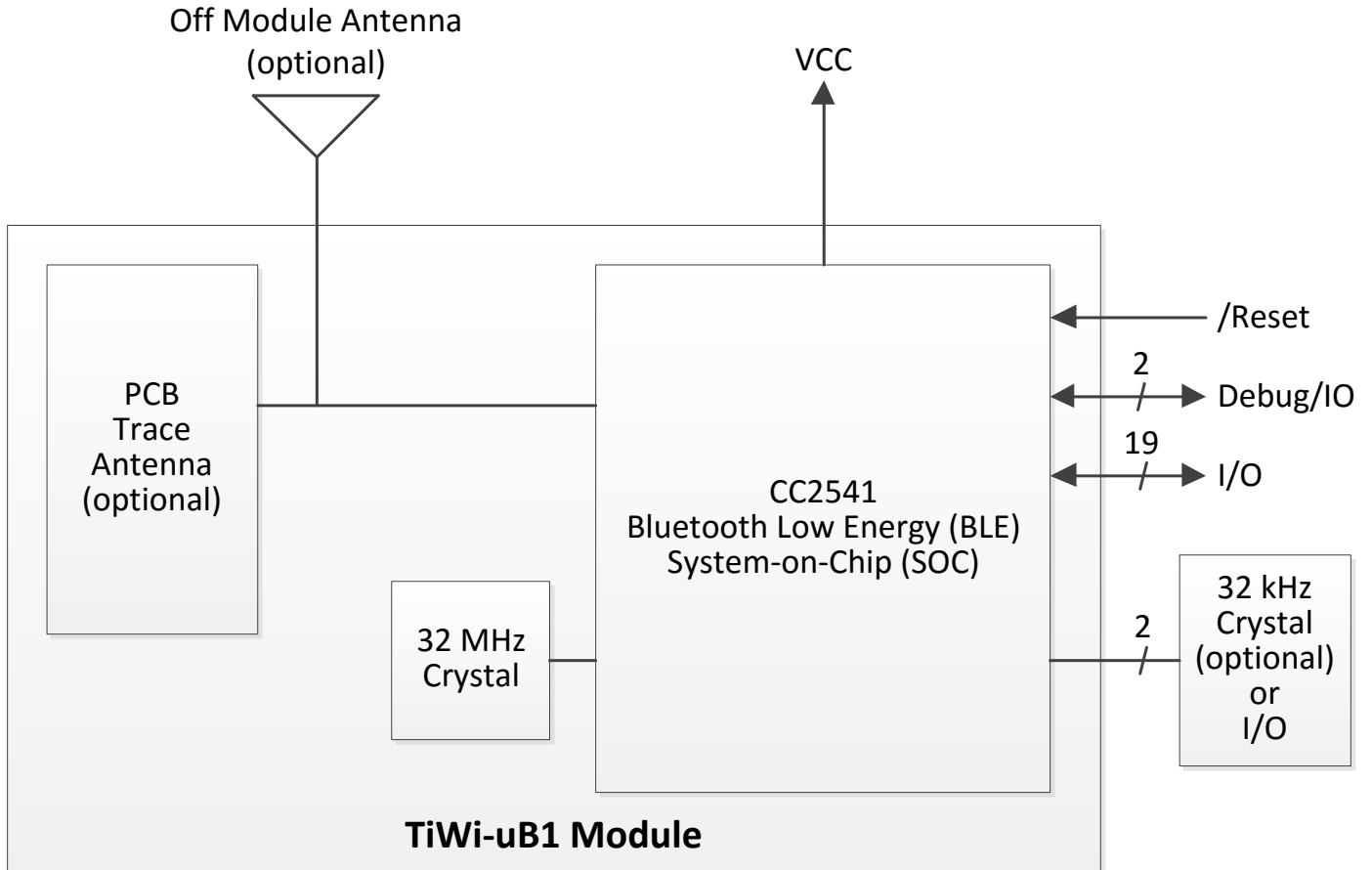

Figure 1 TiWi-uB1 Module Block Diagram

TABLE OF CONTENTS

FEATURES	1
APPLICATIONS	1
DESCRIPTION	1
ORDERING INFORMATION	2
MODULE ACCESSORIES.....	2
BLOCK DIAGRAM	3
FOOTPRINT AND PIN DEFINITIONS	6
PIN DESCRIPTIONS	7
ELECTRICAL SPECIFICATIONS	8
Absolute Maximum Ratings	8
Recommended Operating Conditions	8
General Characteristics	8
General Specifications	9
DC Characteristics	10
Current Consumption	11
CURRENT CONSUMPTION WITH DC to DC Converter	12
RF Characteristics	13
SLOW CLOCK (32 KHZ) SOURCE REQUIREMENTS	15
32.768-kHz EXTERNAL CRYSTAL OSCILLATOR	15
32-kHz INTERNAL RC OSCILLATOR.....	16
SPI INTERFACE CHARACTERISTICS.....	17
DEBUG INTERFACE CHARACTERISTICS	19
SOLDERING RECOMMENDATIONS	21
Recommended Reflow Profile for Lead Free Solder	21
CLEANING	22
OPTICAL INSPECTION	22
REWORK	22

The information in this document is subject to change without notice.

SHIPPING, HANDLING, AND STORAGE	22
Shipping.....	22
Handling	22
Moisture Sensitivity Level (MSL)	22
Storage	22
Repeating Reflow Soldering.....	23
AGENCY CERTIFICATIONS	24
AGENCY STATEMENTS.....	24
Federal Communication Commission Interference Statement	24
Industry Canada Statements.....	25
OEM RESPONSIBILITIES TO COMPLY WITH FCC AND INDUSTRY CANADA REGULATIONS.....	26
OEM LABELING REQUIREMENTS FOR END-PRODUCT	27
OEM END PRODUCT USER MANUAL STATEMENTS.....	28
EUROPE	29
CE Notice	29
Declaration of Conformity (DOC)	29
BLUETOOTH CERTIFICATION.....	29
ANTENNA INFORMATION.....	30
Dipole Antenna 001-0001	30
PCB Trace Antenna	30
MECHANICAL DATA.....	39
PCB FOOTPRINT	40
Tape & Reel Dimensions	41
DEVICE MARKINGS.....	42
Rev 1 Devices.....	42
Rev 2 Devices.....	42
CONTACTING LSR	43

The information in this document is subject to change without notice.

FOOTPRINT AND PIN DEFINITIONS

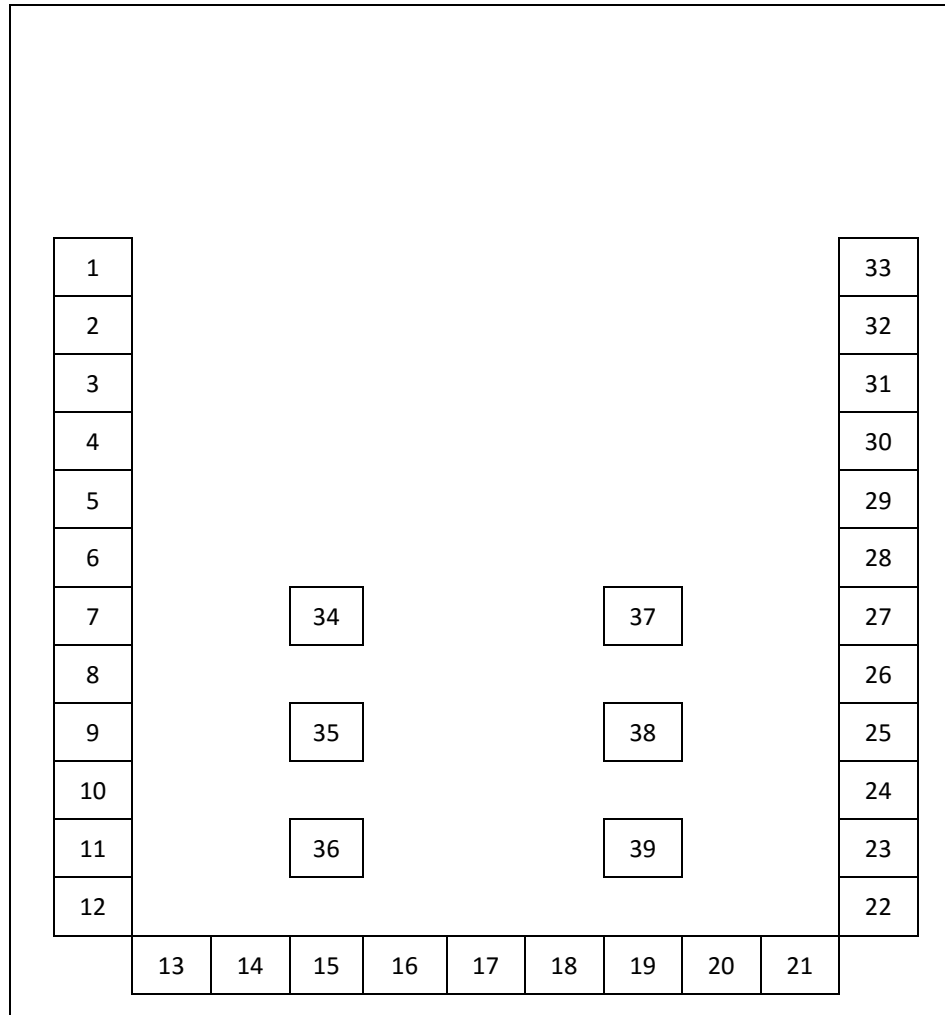

Figure 2 TiWi-uB1 Module Footprint (Viewed From Top)

PIN DESCRIPTIONS

Module Pin	Name	I/O Type	Description
1	RF OUT	RF	ANTENNA. 50 OHMS
2	GND	GND	GROUND
3	GND	GND	GROUND
4	OSC32K Q1/P2 4	AI/DIO	GENERAL PURPOSE DIGITAL I/O
5	OSC32K Q2/P2 3	AI/DIO	32KHZ GENERAL PURPOSE DIGITAL I/O
6	/RESET	DI	ACTIVE LOW RESET. CC2541 INTERNAL PULL-UP
7	DC/P2 2	DI/DIO	DEBUG CLOCK. GENERAL PURPOSE DIGITAL I/O
8	DD/P2 1	DIO	DEBUG DATA. GENERAL PURPOSE DIGITAL I/O
9	NC	-	NO CONNECT (DO NOT CONNECT)
10	NC	-	NO CONNECT (DO NOT CONNECT)
11	AVCC	PI	ANALOG POWER SUPPLY TO MODULE (2.0V – 3.6V)
12	DVCC	PI	DIGITAL POWER TO SUPPLY MODULE (2.0V – 3.6V)
13	P2 0	DIO	GENERAL PURPOSE DIGITAL I/O
14	SCL	DIO	I2C CLOCK. GENERAL PURPOSE DIGITAL I/O
15	SDA	DIO	I2C DATA. GENERAL PURPOSE DIGITAL I/O
16	P1 7	DIO	GENERAL PURPOSE DIGITAL I/O
17	P1 6	DIO	GENERAL PURPOSE DIGITAL I/O
18	P1 5	DIO	GENERAL PURPOSE DIGITAL I/O
19	P1 4	DIO	GENERAL PURPOSE DIGITAL I/O
20	P1 3	DIO	GENERAL PURPOSE DIGITAL I/O
21	P1 2	DIO	GENERAL PURPOSE DIGITAL I/O
22	GND	GND	GROUND
23	P1 1	DIO	GENERAL PURPOSE DIGITAL I/O
24	P1 0	DIO	GENERAL PURPOSE DIGITAL I/O
25	P0 7	DIO	GENERAL PURPOSE DIGITAL I/O. ANALOG INPUT
26	P0 6	DIO	GENERAL PURPOSE DIGITAL I/O. ANALOG INPUT
27	P0 5	DIO	GENERAL PURPOSE DIGITAL I/O. ANALOG INPUT
28	P0 4	DIO	GENERAL PURPOSE DIGITAL I/O. ANALOG INPUT
29	P0 3	DIO	GENERAL PURPOSE DIGITAL I/O. ANALOG INPUT
30	P0 2	DIO	GENERAL PURPOSE DIGITAL I/O. ANALOG INPUT
31	P0 1	DIO	GENERAL PURPOSE DIGITAL I/O. ANALOG INPUT
32	P0 0	DIO	GENERAL PURPOSE DIGITAL I/O. ANALOG INPUT
33	GND	GND	GROUND
34-39	GND	GND	GROUND AND THERMAL RELIEF PADS

PI = Power Input GND = Ground DI = Digital Input DO = Digital Output DIO = Digital Input/Output AI = Analog Input
RF = Bi-directional RF Port Note: See the Texas Instruments CC2541 datasheet and user guide for further details on the I/O.

Table 3 TiWi-uB1 Pin Descriptions

The information in this document is subject to change without notice.

ELECTRICAL SPECIFICATIONS

Absolute Maximum Ratings

Symbol	Description	Min	Max	Unit
DVCC	Digital Input Supply Voltage	-0.3	3.9	V
AVCC	Analog Input Supply Voltage	-0.3	3.9	V
VDIO	Voltage on any digital pin	-0.3	$VDD + 0.3 \leq 3.9$	V

Table 4 Absolute Maximum Ratings¹

Recommended Operating Conditions

Test conditions: Ambient Temp = 25°C

Symbol	Min	Typ	Max	Unit
VCC	2.0	3.3	3.6	V

Table 5 Recommended Operating Conditions

General Characteristics

Characteristic	Description
Model Name	TiWi-uB1
Product Description	Bluetooth Low Energy Wireless Module
Dimension	11.63 mm x 17.86 mm x 2.4 mm (W*L*T)
Operating temperature	-40°C to 85°C
Storage temperature	-40°C to 85°C
Humidity	Operating Humidity 10% to 95% Non-Condensing Storage Humidity 5% to 95% Non-Condensing
Weight	0.18 g +/- 0.01g

Table 6 General Characteristics

¹ Under no circumstances should exceeding the ratings specified in the Absolute Maximum Ratings section be allowed. Stressing the module beyond these limits may result permanent damage to the module that is not covered by the warranty.

General Specifications

Measured on LSR TiWi-uB1 EM reference design with TA = 25°C and VDD = 3 V

Parameter	Test Conditions	Min	Typ	Max	Unit
WAKE-UP AND TIMING					
Power mode 1 → Active	Digital regulator on, 16-MHz RCOSC and 32-MHz crystal oscillator off. Start-up of 16-MHz RCOSC	4			μS
Power mode 2 or 3 → Active	Digital regulator off, 16-MHz RCOSC and 32-MHz crystal oscillator off. Start-up of regulator and 16-MHz RCOSC	120			μS
Active → TX or RX	Crystal ESR = 16 Ω. Initially running on 16-MHz RCOSC, with 32-MHz XOSC OFF	500			μS
	With 32-MHz XOSC initially on	180			μS
RX/TX turnaround	Proprietary auto mode	130			μS
	BLE mode	150			
Data rate and modulation format	2 Mbps, GFSK, 500-kHz deviation 2 Mbps, GFSK, 320-kHz deviation 1 Mbps, GFSK, 250-kHz deviation 1 Mbps, GFSK, 160-kHz deviation 500 kbps, MSK (Proprietary RF Only) 250 kbps, GFSK, 160-kHz deviation 250 kbps, MSK (Proprietary RF Only)				

Table 7 Bluetooth General Specifications

DC Characteristics

Parameter	Test Conditions	Min	Typ	Max	Unit
Logic-0 input voltage				0.5	V
Logic-1 input voltage		2.4			V
Logic-0 input current	Input equals 0 V	-50		50	nA
Logic-1 input current	Input equals VDD	-50		50	nA
I/O-pin pullup/pulldown resistors			20		kΩ
Logic-0 output voltage, 4- mA pins	Output load 4 mA			0.5	V
Logic-1 output voltage, 4-mA pins	Output load 4 mA		2.5		V
Logic-0 output voltage, 20- mA pins	Output load 20 mA			0.5	V
Logic-1 output voltage, 20-mA pins	Output load 20 mA		2.5		V

Table 8 Bluetooth General DC Characteristics

Current Consumption

Measured on LSR TiWi-uB1 EM reference design with TA = 25°C, VDD = 3.3 V, fc = 2440 MHz. LEDs disabled, DC to DC disabled.

Mode	Description	Average Current	Unit
I _{core} Core current consumption	RX mode, standard mode, no peripherals active, low MCU activity	25.7	mA
	RX mode, high-gain mode, no peripherals active, low MCU activity	28.1	
	TX mode, -23 dBm output power, no peripherals active, low MCU activity	20.2	
	TX mode, 0 dBm output power, no peripherals active, low MCU activity	21.1	
	Power mode 1. Digital regulator on; 16-MHz RCOSC and 32-MHz crystal oscillator off; 32.768-kHz XOSC, POR, BOD and sleep timer active; RAM and register retention	270	μA
	Power mode 2. Digital regulator off; 16-MHz RCOSC and 32-MHz crystal oscillator off; 32.768-kHz XOSC, POR, and sleep timer active; RAM and register retention	1	
	Power mode 3. Digital regulator off; no clocks; POR active; 0.5 RAM and register retention	0.5	
	Low MCU activity: 32-MHz XOSC running. No radio or peripherals. Limited flash access, no RAM access.	6.7	mA
I _{peri} Peripheral current consumption *Adds to core current I _{core} for each peripheral unit activated	Timer 1. Timer running, 32-MHz XOSC used	90	μA
	Timer 2. Timer running, 32-MHz XOSC used	90	
	Timer 3. Timer running, 32-MHz XOSC used	60	
	Timer 4. Timer running, 32-MHz XOSC used	70	
	Sleep timer, including 32.753-kHz RCOSC	0.6	
	ADC, when converting	1.2	mA

Table 9 Bluetooth General DC Characteristics

CURRENT CONSUMPTION WITH DC to DC Converter

Measured on LSR TiWi-uB1 EM reference design with TA = 25°C, VDD = 3.3 V, fc = 2440 MHz. LEDs disabled, DC to DC Enabled 1 Mbps, GFSK, 250-kHz deviation, Bluetooth™ low energy Mode, 1% BER.

Mode	Description	Average Current	Unit
Current consumption	RX mode, standard mode, no peripherals active, low MCU activity	15.7	mA
	RX mode, high-gain mode, no peripherals active, low MCU activity	17.4	
	TX mode, -23 dBm output power, no peripherals active, low MCU activity	12.0	
	TX mode, 0 dBm output power, no peripherals active, low MCU activity	12.6	

Table 10 Bluetooth Power Consumption

RF Characteristics

Measured on LSR TiWi-uB1 EM reference design with TA = 25°C, VDD = 3.3 V, fc = 2440 MHz. LEDs disabled, DC to DC disabled, measured at RF connector.

Parameter	Test Conditions	Min	Typ	Max	Unit
TRANSMIT SECTION					
Output Power	Measured on LSR TiWi-uB1 450-0106 EM reference design at RF connector using maximum recommended output power setting		0		dBm
	Measured on LSR TiWi-uB1 450-0106 EM reference design at RF connector using minimum recommended output power setting		-23		
Spurious emission conducted measurement	f < 1 GHz		-52		dBm
	f > 1 GHz		-48		dBm
RF frequency range	Programmable in 1-MHz steps	2379		2496	MHz
RECEIVE SECTION					
Receiver sensitivity	1 Mbps, GFSK, 250-kHz Deviation, <i>Bluetooth</i> low energy Mode, 0.1% BER, High Gain Mode		-94		dBm
	1 Mbps, GFSK, 250-kHz Deviation, <i>Bluetooth</i> low energy Mode, 0.1% BER, Standard Gain Mode		-88		dBm
Saturation ⁽²⁾	BER < 0.1%		5		dBm
Co-channel rejection ⁽²⁾	Wanted signal -67 dBm		-6		dB
Frequency error tolerance	Including both initial tolerance and drift. Sensitivity better than -67dBm, 250 byte payload. BER 0.1%	-250		250	KHz
Intermodulation (1)	Minimum interferer level		-36		dBm

Table 11 Bluetooth RF Characteristics

- Results based on standard-gain mode.

SLOW CLOCK (32 KHZ) SOURCE REQUIREMENTS

Two 32-kHz oscillators are available in the device as clock sources for the 32-kHz clock:

- 32-kHz XOSC – External Crystal Oscillator
- 32-kHz RCOSC – Internal RC Oscillator

By default, after a reset, the 32-kHz RCOSC is enabled and selected as the 32-kHz clock source. The RCOSC consumes less power, but is less accurate compared to the 32-kHz XOSC. The chosen 32-kHz clock source drives the Sleep Timer, generates the tick for the Watchdog Timer, and is used as a strobe in Timer 2 to calculate the Sleep Timer sleep time.

The crystal is required for accurate sleep timing, so it is only needed to for the module be BLE certified when using low power modes.

32.768-KHZ EXTERNAL CRYSTAL OSCILLATOR

Characteristic	Condition	Min	Typ	Max	Unit
Crystal frequency			32768		Hz
Crystal frequency accuracy requirement		-40		40	ppm
ESR Equivalent series Resistance			40	130	kΩ
C ₀ Crystal shunt Capacitance			0.9	2	pF
C _L Crystal load capacitance			12	16	pF
Start-up time			0.4		mS

Table 12 32 kHz External Clock Requirements

32-kHz INTERNAL RC OSCILLATOR

Characteristic	Condition	Min	Typ	Max	Unit
Calibrated frequency (1)			32768		Hz
Frequency accuracy after calibration		-40		40	ppm
Temperature coefficient (2)			±0.2		%
Supply-voltage coefficient			3		%/V
Calibration time (3)			2		mS

Table 13 32 kHz Internal Clock Requirements

- 1) The calibrated 32-kHz RC oscillator frequency is 32-MHz divided by 977.
- 2) Frequency drift when temperature changes after calibration.
- 3) When the 32-kHz RC oscillator is enabled, it is calibrated when a switch from the 16-MHz RC oscillator to the 32-MHz crystal oscillator is performed while SLEEP_CMD.OSC32K_CALDIS is set to 0.

SPI INTERFACE CHARACTERISTICS

TA = -40°C to 85°C, VDD = 2 V to 3.6 V

Characteristic	Condition	Min	Typ	Max	Unit
t ₁ SCK period	Master, RX and TX	250			nS
	Slave, RX and TX	250			
SCK duty cycle	Master		50%		
t ₂ SSN low to SCK	Master	63			nS
	Slave	63			
t ₃ SCK to SSN high	Master	63			nS
	Slave	63			
T ₄ SCK to SSN high	Master, load = 10 pF			7	nS
t ₅ MOSI late out	Master, load = 10 pF			10	nS
t ₆ MISO setup	Master				nS
t ₇ MISO hold	Master				nS
SCK duty cycle	Slave		50%		
t ₁₀ MOSI setup	Slave				nS
t ₁₁ MOSI hold	Slave				nS
t ₉ MISO late out	Slave, load = 10 pF				nS
Operating frequency	Master, TX only			8	MHz
	Master, RX and TX			4	
	Slave, RX only			8	
	Slave, RX and TX			4	

Table 14 SPI Timing

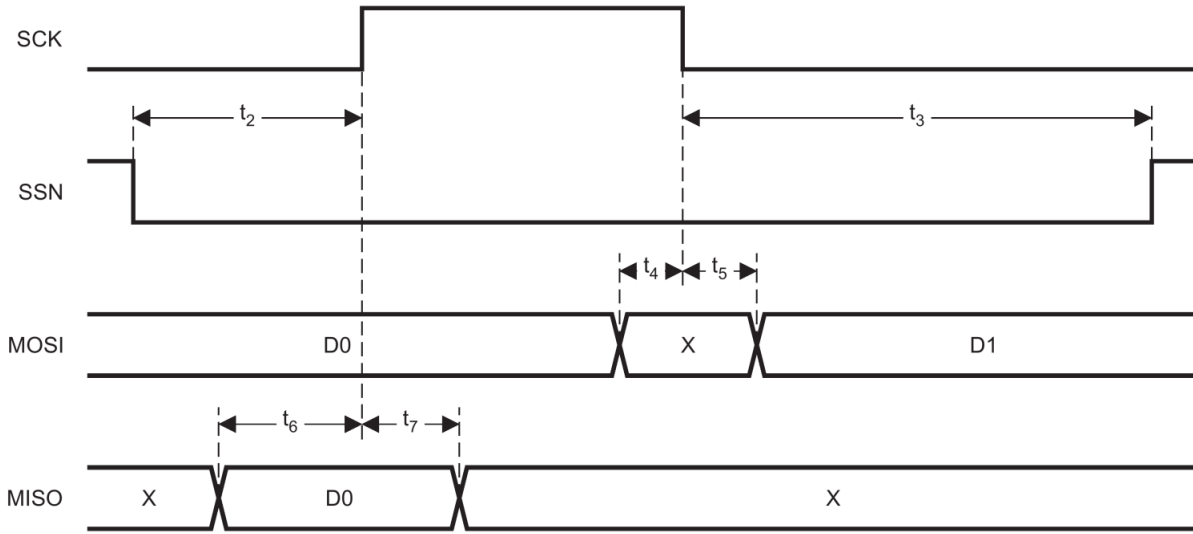

Figure 3 SPI Master Timing

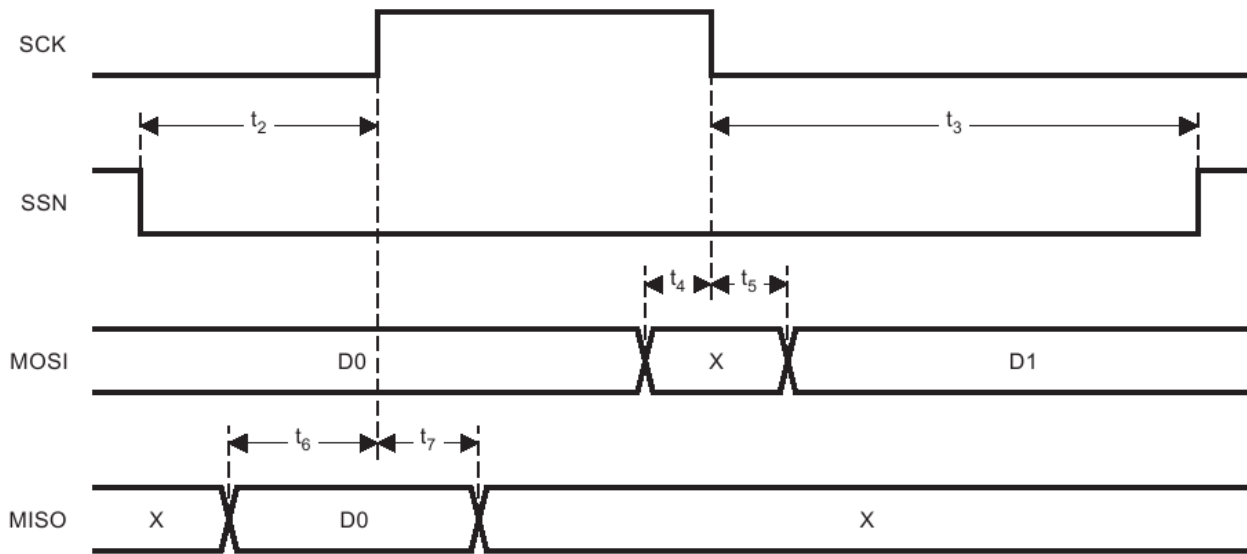

Figure 4 Slave Timing

DEBUG INTERFACE CHARACTERISTICS

TA = -40°C to 85°C, VDD = 2 V to 3.6 V

Characteristic	Condition	Min	Typ	Max	Unit
f _{clk_dbg} Debug clock frequency (see Figure 5)				12	MHz
t ₁ Allowed high pulse on clock (see Figure 5)		35			ns
t ₂ Allowed low pulse on clock (see Figure 5)		35			ns
t ₃ EXT_RESET_N low to first falling edge on debug clock (see Figure 7)		167			ns
t ₄ Falling edge on clock to EXT_RESET_N high (see Figure 7)		83			ns
t ₆ EXT_RESET_N high to first debug command (see Figure 7)		83			ns
t ₆ Debug data setup (see Figure 6)		2			ns
t ₇ Debug data hold (see Figure 6)		4			ns
t ₈ Clock-to-data delay (see Figure 6)	Load = 10 pF				ns

Table 15 Debug Interface Timing

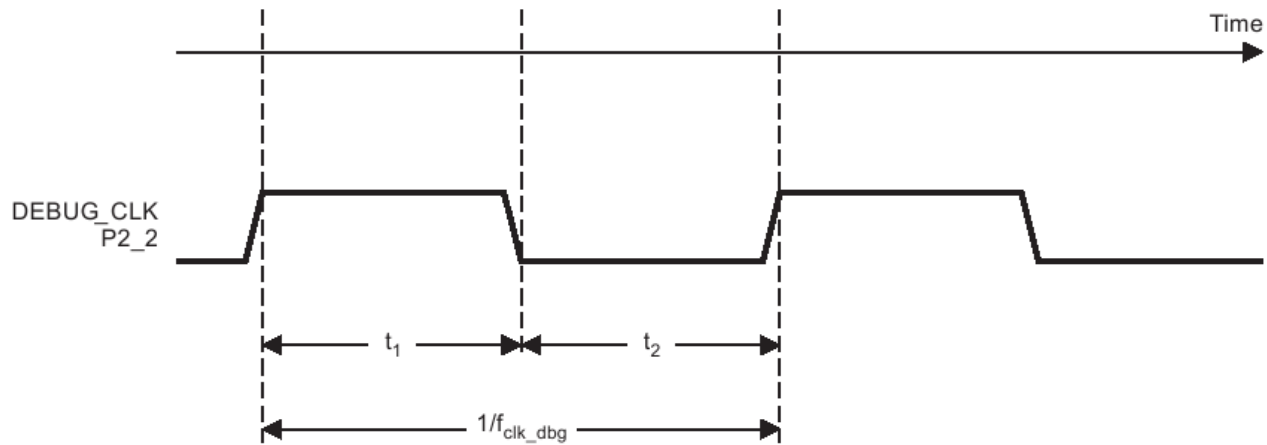

Figure 5 Slave Timing

The information in this document is subject to change without notice.

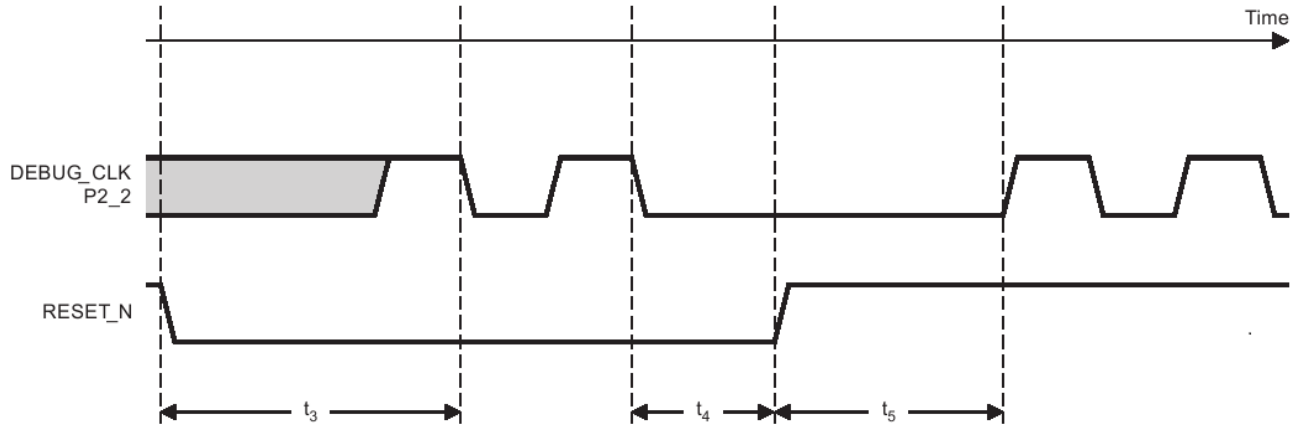

Figure 6 Slave Timing

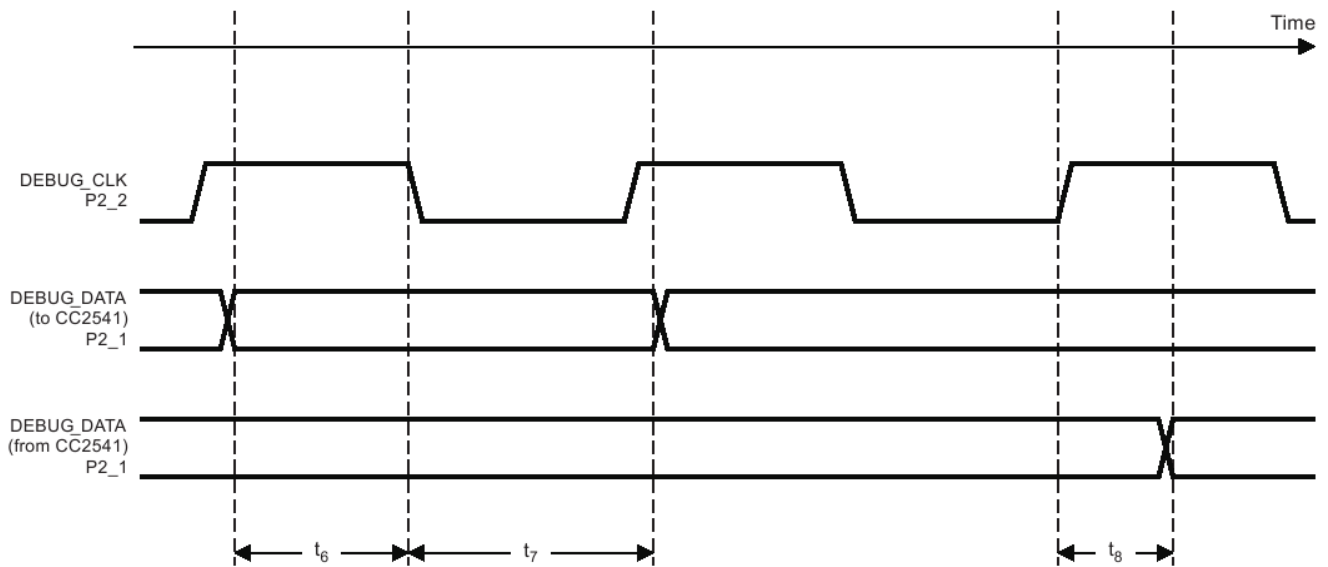

Figure 7 Slave Timing

SOLDERING RECOMMENDATIONS

Recommended Reflow Profile for Lead Free Solder

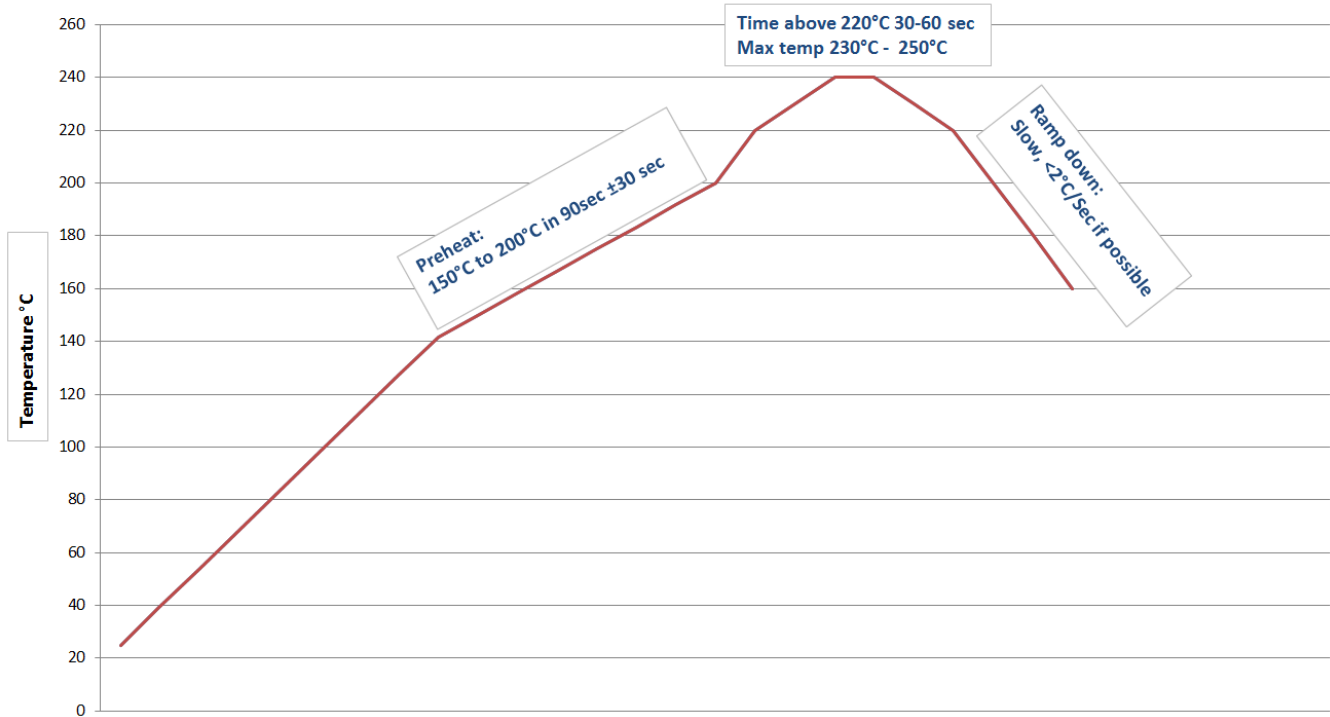

Figure 8 Recommended Soldering Profile

Note: The quality of solder joints on the surface mount pads where they contact the host board should meet the appropriate IPC Specification. See IPC-A-610-D Acceptability of Electronic Assemblies, section 8.2.1 “Bottom Only Terminations.”

CLEANING

In general, cleaning the populated modules is strongly discouraged. Residuals under the module cannot be easily removed with any cleaning process.

- Cleaning with water can lead to capillary effects where water is absorbed into the gap between the host board and the module. The combination of soldering flux residuals and encapsulated water could lead to short circuits between neighboring pads. Water could also damage any stickers or labels.
- Cleaning with alcohol or a similar organic solvent will likely flood soldering flux residuals into the RF shield, which is not accessible for post-washing inspection. The solvent could also damage any stickers or labels.
- Ultrasonic cleaning could damage the module permanently.

OPTICAL INSPECTION

After soldering the Module to the host board, consider optical inspection to check the following:

- Proper alignment and centering of the module over the pads.
- Proper solder joints on all pads.
- Excessive solder or contacts to neighboring pads, or vias.

REWORK

The module can be unsoldered from the host board if the Moisture Sensitivity Level (MSL) requirements are met as described in this datasheet.

Never attempt a rework on the module itself, e.g. replacing individual components. Such actions will terminate warranty coverage.

SHIPPING, HANDLING, AND STORAGE

Shipping

Bulk orders of the TiWi-uB1 modules are delivered in reels of 1,000.

Handling

The TiWi-uB1 modules contain a highly sensitive electronic circuitry. Handling without proper ESD protection may damage the module permanently.

Moisture Sensitivity Level (MSL)

Per J-STD-020, devices rated as MSL 4 and not stored in a sealed bag with desiccant pack should be baked prior to use.

Devices are packaged in a Moisture Barrier Bag with a desiccant pack and Humidity Indicator Card (HIC). Devices that will be subjected to reflow should reference the HIC and J-STD-033 to determine if baking is required.

If baking is required, refer to J-STD-033 for bake procedure.

Storage

Per J-STD-033, the shelf life of devices in a Moisture Barrier Bag is 12 months at <40°C and <90% room humidity (RH).

Do not store in salty air or in an environment with a high concentration of corrosive gas, such as Cl₂, H₂S, NH₃, SO₂, or NO_x.

Do not store in direct sunlight.

The product should not be subject to excessive mechanical shock.

Repeating Reflow Soldering

Only a single reflow soldering process is encouraged for host boards.

AGENCY CERTIFICATIONS

FCC ID: TFB-BT2, 15.247

IC ID: 5969A-BT2, RSS 210

CE: Compliant to standards EN 60950-1, EN 300 328, and EN 301 489

Giteki: 209-J00156

AGENCY STATEMENTS

Federal Communication Commission Interference Statement

This equipment has been tested and found to comply with the limits for a Class B digital device, pursuant to Part 15 of the FCC Rules. These limits are designed to provide reasonable protection against harmful interference in a residential installation. This equipment generates uses and can radiate radio frequency energy and, if not installed and used in accordance with the instructions, may cause harmful interference to radio communications. However, there is no guarantee that interference will not occur in a particular installation. If this equipment does cause harmful interference to radio or television reception, which can be determined by turning the equipment off and on, the user is encouraged to try to correct the interference by one of the following measures:

- Reorient or relocate the receiving antenna.
- Increase the separation between the equipment and receiver.
- Connect the equipment into an outlet on a circuit different from that to which the receiver is connected.
- Consult the dealer or an experienced radio/TV technician for help.

This device complies with Part 15 of the FCC Rules. Operation is subject to the following two conditions: (1) This device may not cause harmful interference, and (2) this device must accept any interference received, including interference that may cause undesired operation.

This portable transmitter with its antenna complies with FCC/IC RF exposure limits for general population / uncontrolled exposure.

FCC CAUTION: Any changes or modifications not expressly approved by the party responsible for compliance could void the user's authority to operate this equipment.

Industry Canada Statements

This device complies with Industry Canada License-exempt RSS standard(s). Operation is subject to the following two conditions: (1) this device may not cause interference, and (2) this device must accept any interference, including interference that may cause undesired operation of the device.

To reduce potential radio interference to other users, the antenna type and its gain should be so chosen that the equivalent isotropically radiated power (e.i.r.p.) is not more than that permitted for successful communication.

This device has been designed to operate with the antenna(s) listed below, and having a maximum gain of -4.2 dBi (PCB Trace) and 2.0dBi (LSR 2.4 GHz Dipole). Antennas not included in this list or having a gain greater than -4.2 dBi and 2.0 dBi are strictly prohibited for use with this device. The required antenna impedance is 50 ohms.

List of all Antennas Acceptable for use with the Transmitter

- 1) On module PCB trace antenna.
- 2) LSR 001-0001 center-fed 2.4 GHz dipole antenna and LSR 080-0001 U.FL to Reverse Polarity SMA connector cable.

Cet appareil est conforme aux normes d'Industrie Canada exempts de licence RSS (s). L'opération est soumise aux deux conditions suivantes: (1) cet appareil ne peut pas provoquer d'interférences et (2) cet appareil doit accepter toute interférence, y compris les interférences qui peuvent causer un mauvais fonctionnement de l'appareil.

Pour réduire le risque d'interférence aux autres utilisateurs, le type d'antenne et son gain doivent être choisis de manière que la puissance isotrope rayonnée équivalente (PIRE) ne dépasse pas celle permise pour une communication réussie.

Cet appareil a été conçu pour fonctionner avec l'antenne (s) ci-dessous, et ayant un gain maximum de -4,2 dBi (PCB Trace) et 2,0 dBi (LSR 2.4 GHz Dipole). Antennes pas inclus dans cette liste ou présentant un gain supérieur à -4,2 dBi et 2,0 dBi sont strictement interdits pour une utilisation avec cet appareil. L'impédance d'antenne requise est de 50 ohms.

Liste de toutes les antennes acceptables pour une utilisation avec l'émetteur

- 1) Le module d'antenne PCB trace.
- 2) LSR 001-0001 centre-fed 2,4 GHz antenne dipôle et LSR 080-0001 U.FL pour inverser câble connecteur SMA à polarité.

OEM RESPONSIBILITIES TO COMPLY WITH FCC AND INDUSTRY CANADA REGULATIONS

The TiWi-uB1 Module has been certified for integration into products only by OEM integrators under the following conditions:

The antennas for this transmitter must not be co-located with any other transmitters except in accordance with FCC and Industry Canada multi-transmitter procedures. Co-location means having a separation distance of less than 20 cm between transmitting antennas.

As long as the two conditions above are met, further transmitter testing will not be required. However, the OEM integrator is still responsible for testing their end-product for any additional compliance requirements required with this module installed (for example, digital device emissions, PC peripheral requirements, etc.).

IMPORTANT NOTE: In the event that these conditions cannot be met (for certain configurations or co-location with another transmitter), then the FCC and Industry Canada authorizations are no longer considered valid and the FCC ID and IC Certification Number cannot be used on the final product. In these circumstances, the OEM integrator will be responsible for re-evaluating the end product (including the transmitter) and obtaining a separate FCC and Industry Canada authorization.

Le module de TiWi-uB1 a été certifié pour l'intégration dans des produits uniquement par des intégrateurs OEM dans les conditions suivantes:

Les antennes pour ce transmetteur ne doit pas être co-localisés avec les autres émetteurs sauf en conformité avec la FCC et Industrie Canada multi-émetteur procédures. Co-localisation des moyens ayant une distance de séparation inférieure à 20 cm entre les antennes d'émission.

Tant que les deux conditions précitées sont réunies, les tests de transmetteurs supplémentaires ne seront pas tenus. Toutefois, l'intégrateur OEM est toujours responsable de tester leur produit final pour toutes les exigences de conformité supplémentaires requis avec ce module installé (par exemple, les émissions appareil numérique, les exigences de périphériques PC, etc.)

NOTE IMPORTANTE: Dans le cas où ces conditions ne peuvent être satisfaites (pour certaines configurations ou de co-implantation avec un autre émetteur), puis la FCC et Industrie autorisations Canada ne sont plus considérés comme valides et l'ID de la FCC et IC numéro de certification ne peut pas être utilisé sur la produit final. Dans ces circonstances, l'intégrateur OEM sera chargé de réévaluer le produit final (y compris l'émetteur) et l'obtention d'un distincte de la FCC et Industrie Canada l'autorisation.

OEM LABELING REQUIREMENTS FOR END-PRODUCT

The TiWi-uB1 module is labeled with its own FCC ID and IC Certification Number. The FCC ID and IC certification numbers are not visible when the module is installed inside another device, as such the end device into which the module is installed must display a label referring to the enclosed module. The final end product must be labeled in a visible area with the following:

“Contains Transmitter Module FCC ID: TFB-BT2”

“Contains Transmitter Module IC: 5969A-BT2”

or

“Contains FCC ID: TFB-BT2”

“Contains IC: 5969A-BT2”

The OEM of the TiWi-uB1 Module must only use the approved antenna(s) listed above, which have been certified with this module.

Le module de TiWi-uB1 est étiqueté avec son propre ID de la FCC et IC numéro de certification. L'ID de la FCC et IC numéros de certification ne sont pas visibles lorsque le module est installé à l'intérieur d'un autre appareil, comme par exemple le terminal dans lequel le module est installé doit afficher une étiquette faisant référence au module ci-joint. Le produit final doit être étiqueté dans un endroit visible par le suivant:

“Contient Module émetteur FCC ID: TFB-BT2”

“Contient Module émetteur IC: 5969A-BT2”

ou

“Contient FCC ID: TFB-BT2”

“Contient IC: 5969A-BT2”

Les OEM du module TiWi-uB1 ne doit utiliser l'antenne approuvée (s) ci-dessus, qui ont été certifiés avec ce module.

OEM END PRODUCT USER MANUAL STATEMENTS

The OEM integrator should not provide information to the end user regarding how to install or remove this RF module or change RF related parameters in the user manual of the end product.

Other user manual statements may apply.

L'intégrateur OEM ne devraient pas fournir des informations à l'utilisateur final sur la façon d'installer ou de supprimer ce module RF ou modifier les paramètres liés RF dans le manuel utilisateur du produit final.

Autres déclarations manuel de l'utilisateur peuvent s'appliquer.

EUROPE

CE Notice

This device has been tested and certified for use in the European Union. See the Declaration of Conformity (DOC) for specifics.

If this device is used in a product, the OEM has responsibility to verify compliance of the final product to the EU standards. A Declaration of Conformity must be issued and kept on file as described in the Radio and Telecommunications Terminal Equipment (R&TTE) Directive.

The 'CE' mark must be placed on the OEM product per the labeling requirements of the Directive.

Declaration of Conformity (DOC)

The DOC can be downloaded from the LSR Wiki.

BLUETOOTH CERTIFICATION

The TiWi-uB1 module has been certified as a Controller Subsystem and has a QDID of B021230.

ANTENNA INFORMATION

Dipole Antenna 001-0001

See antenna datasheet.

PCB Trace Antenna

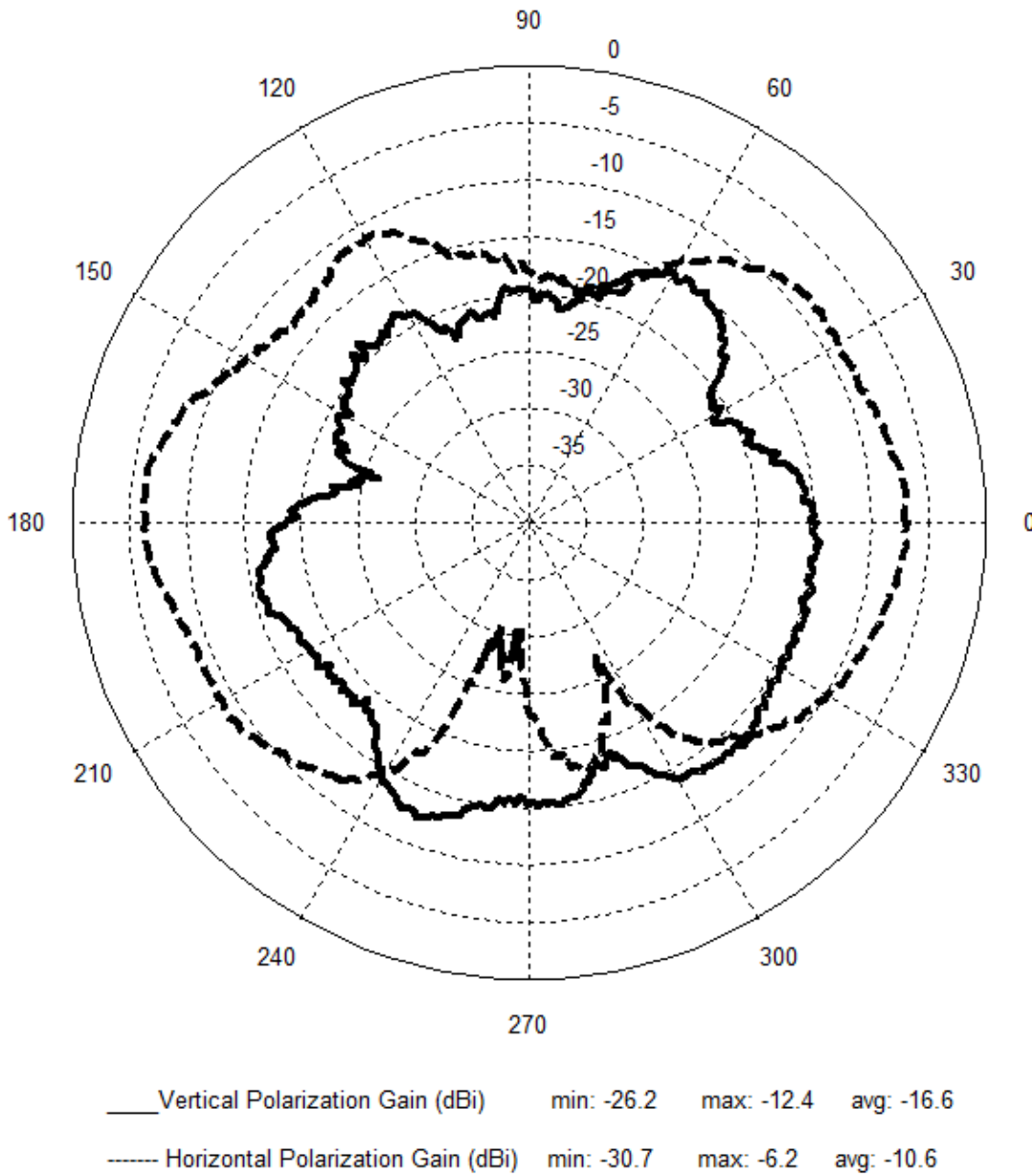
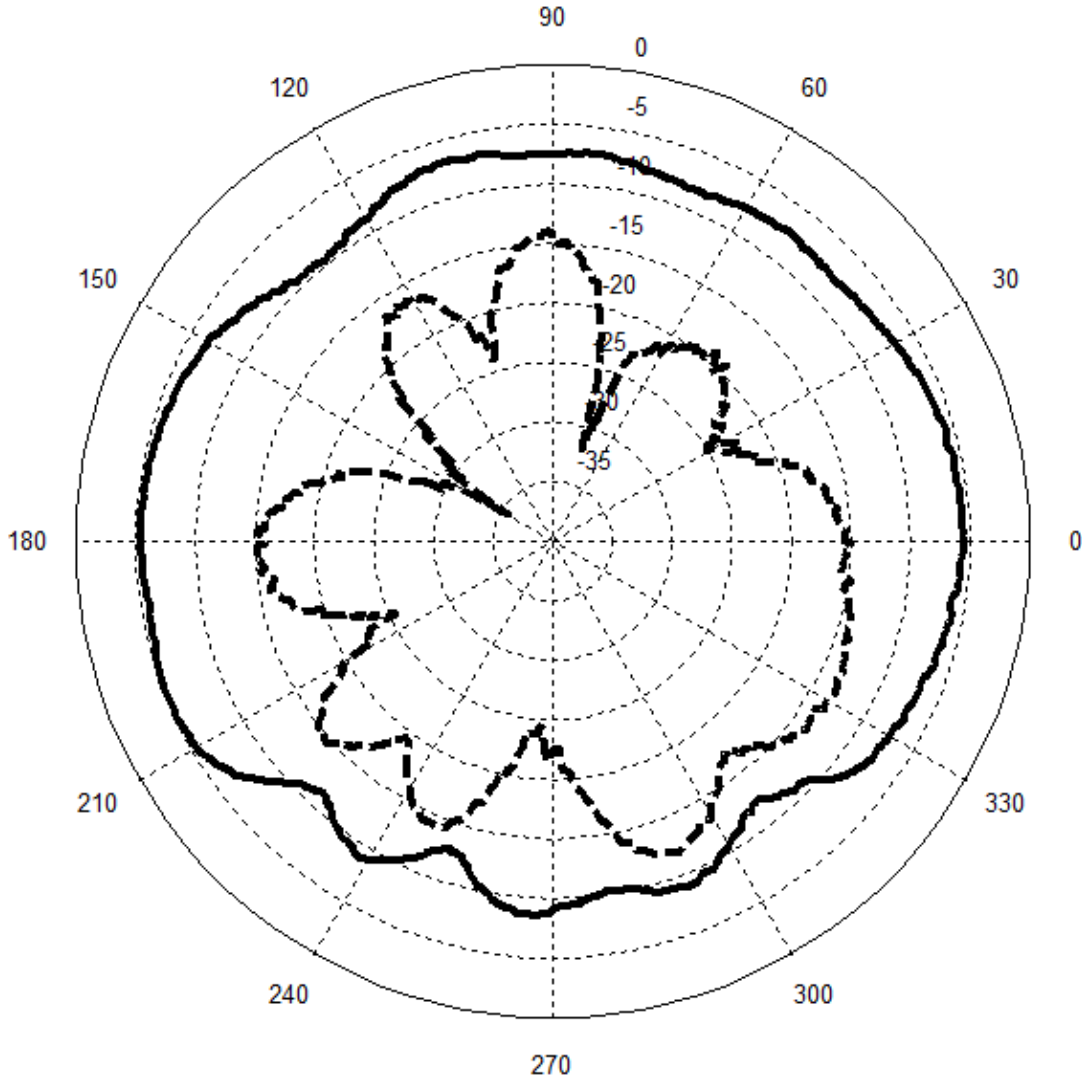

Figure 9 PCB Trace Antenna Pattern (Vertical @ 2405 MHz)

The information in this document is subject to change without notice.



— Vertical Polarization Gain (dBi)	min: -12.8	max: -5.2	avg: -7.4
- - - Horizontal Polarization Gain (dBi)	min: -35.7	max: -11.8	avg: -16.9

Figure 10 PCB Trace Antenna Pattern (Horizontal @ 2405 MHz)

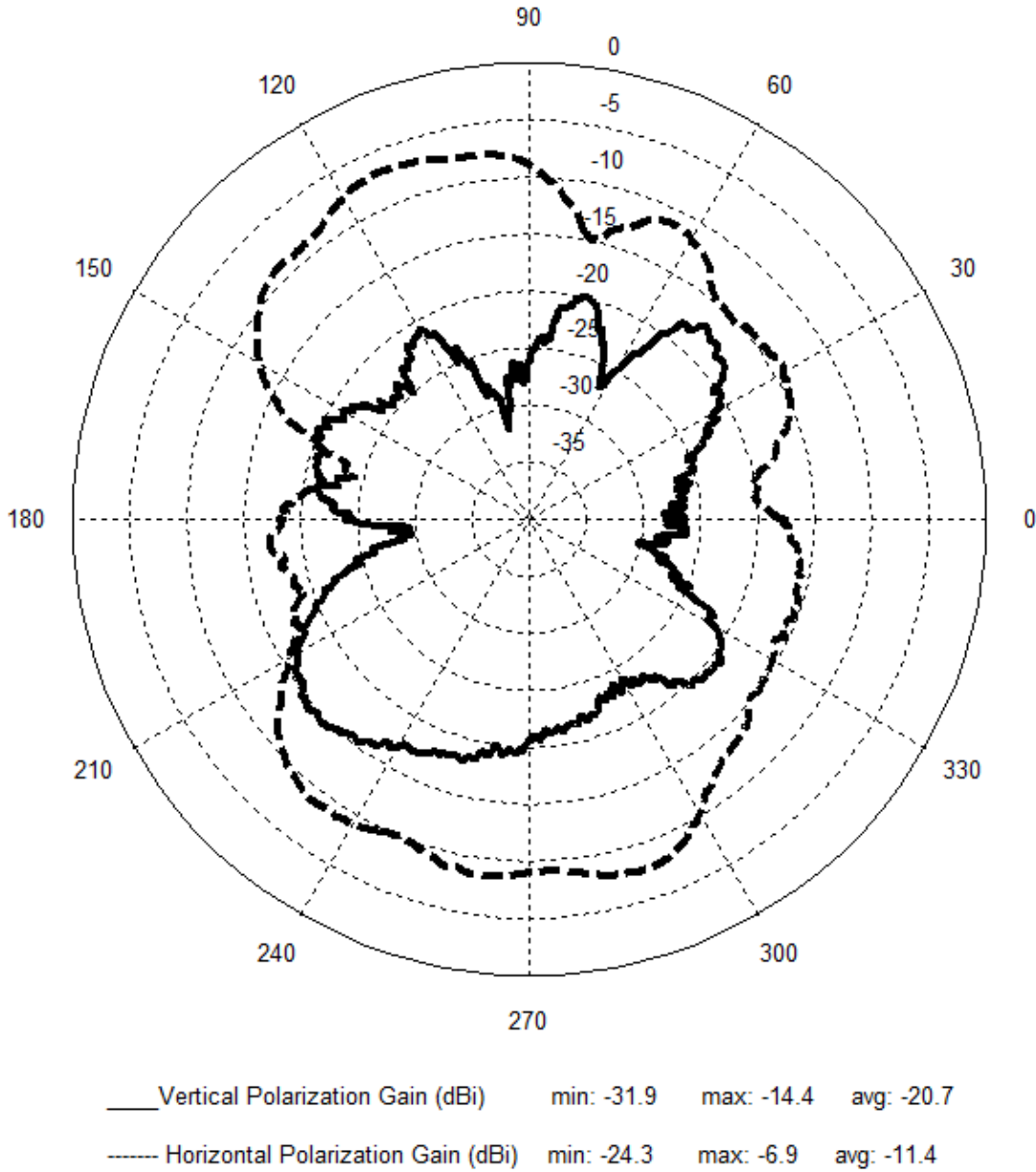

Figure 11 PCB Trace Antenna Pattern (Flat @ 2405 MHz)

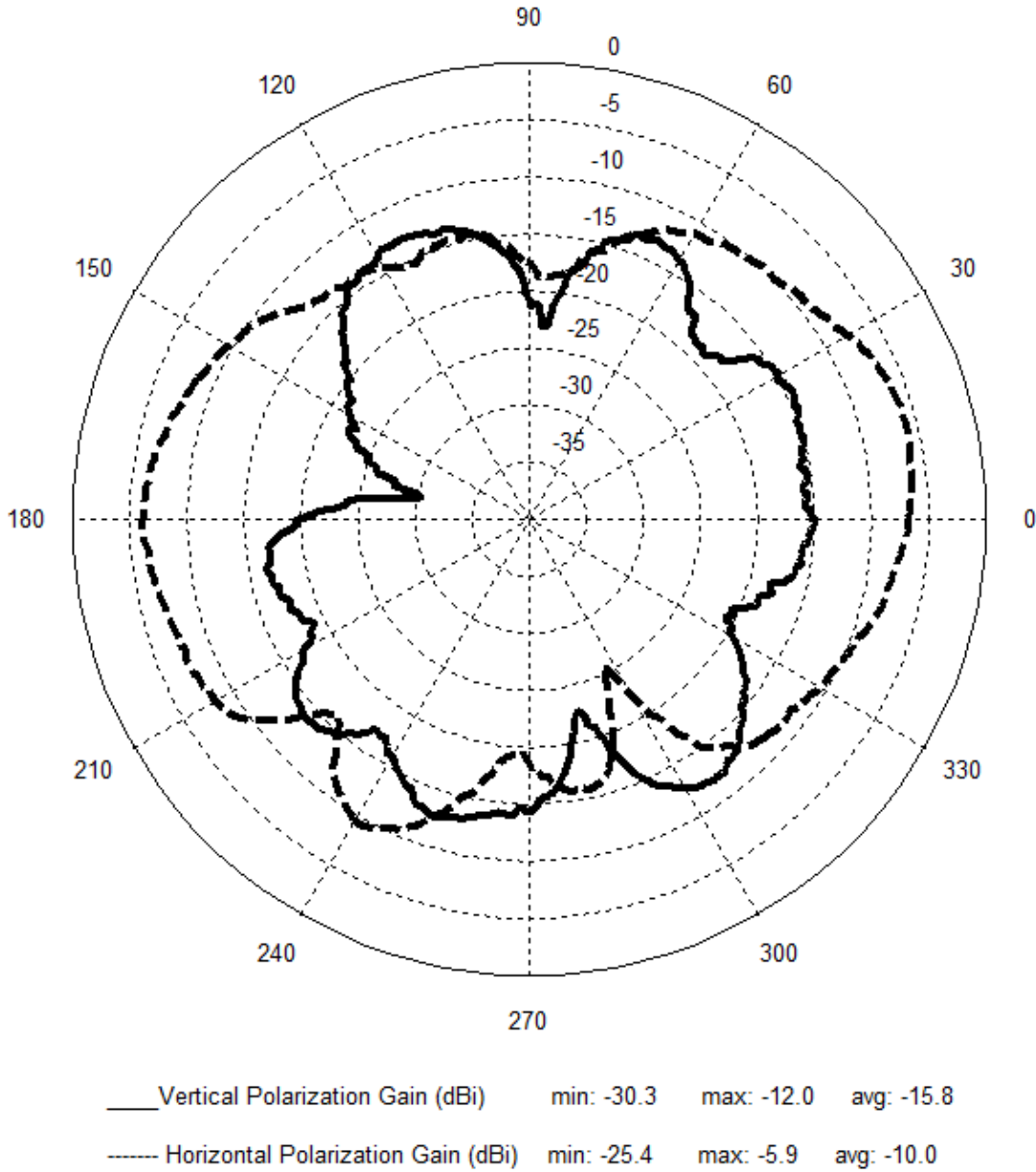

Figure 12 PCB Trace Antenna Pattern (Vertical @ 2440 MHz)

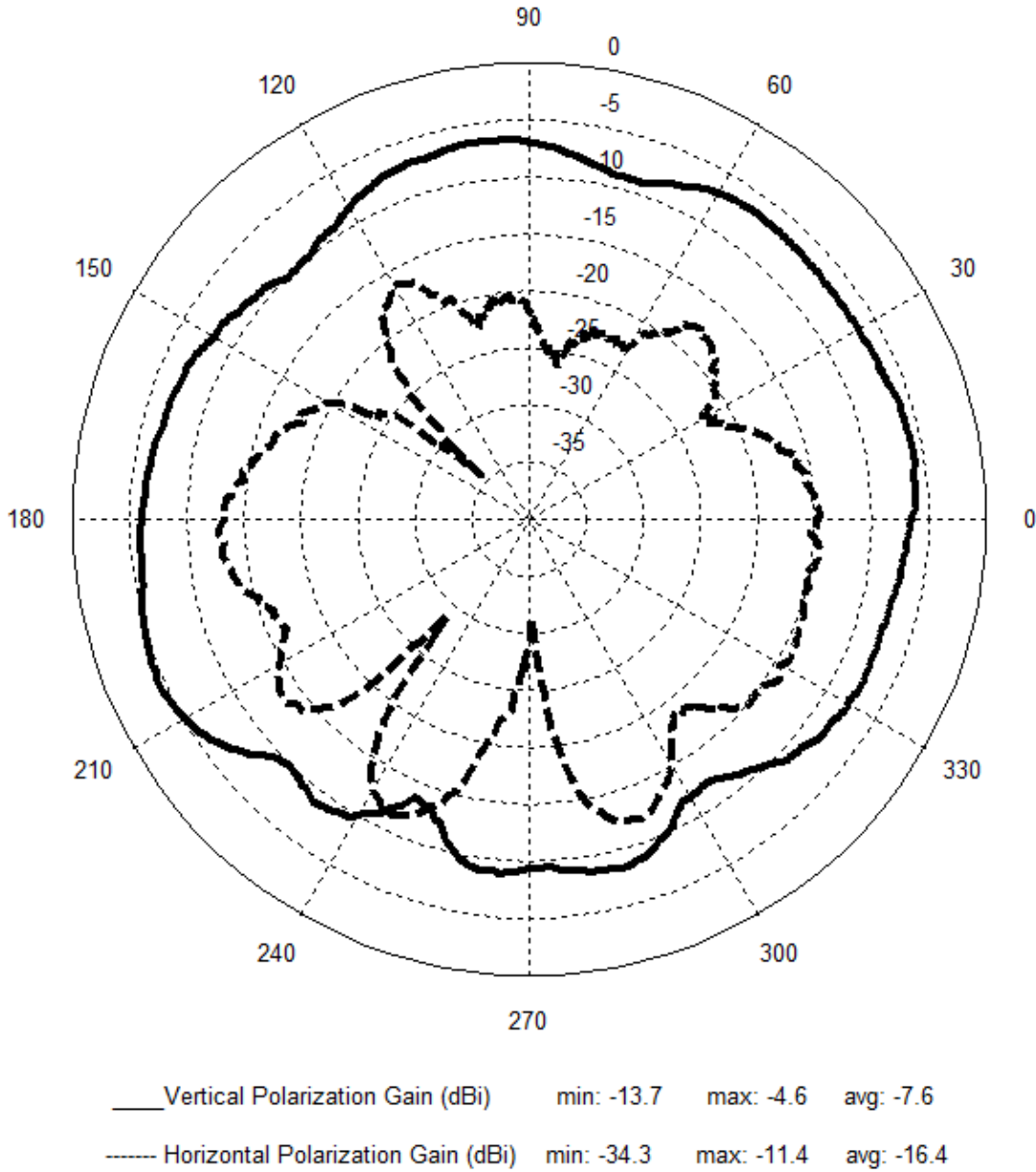
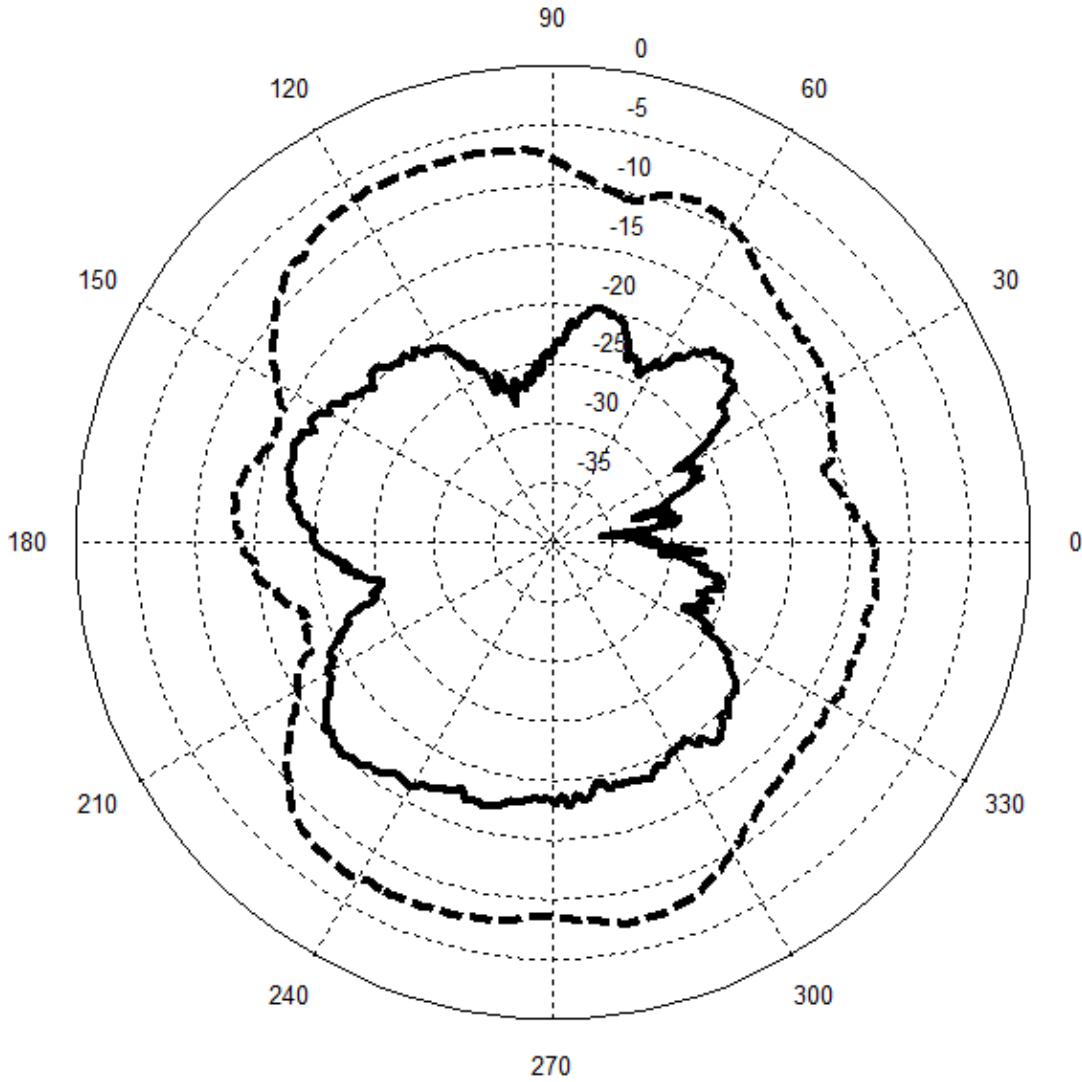
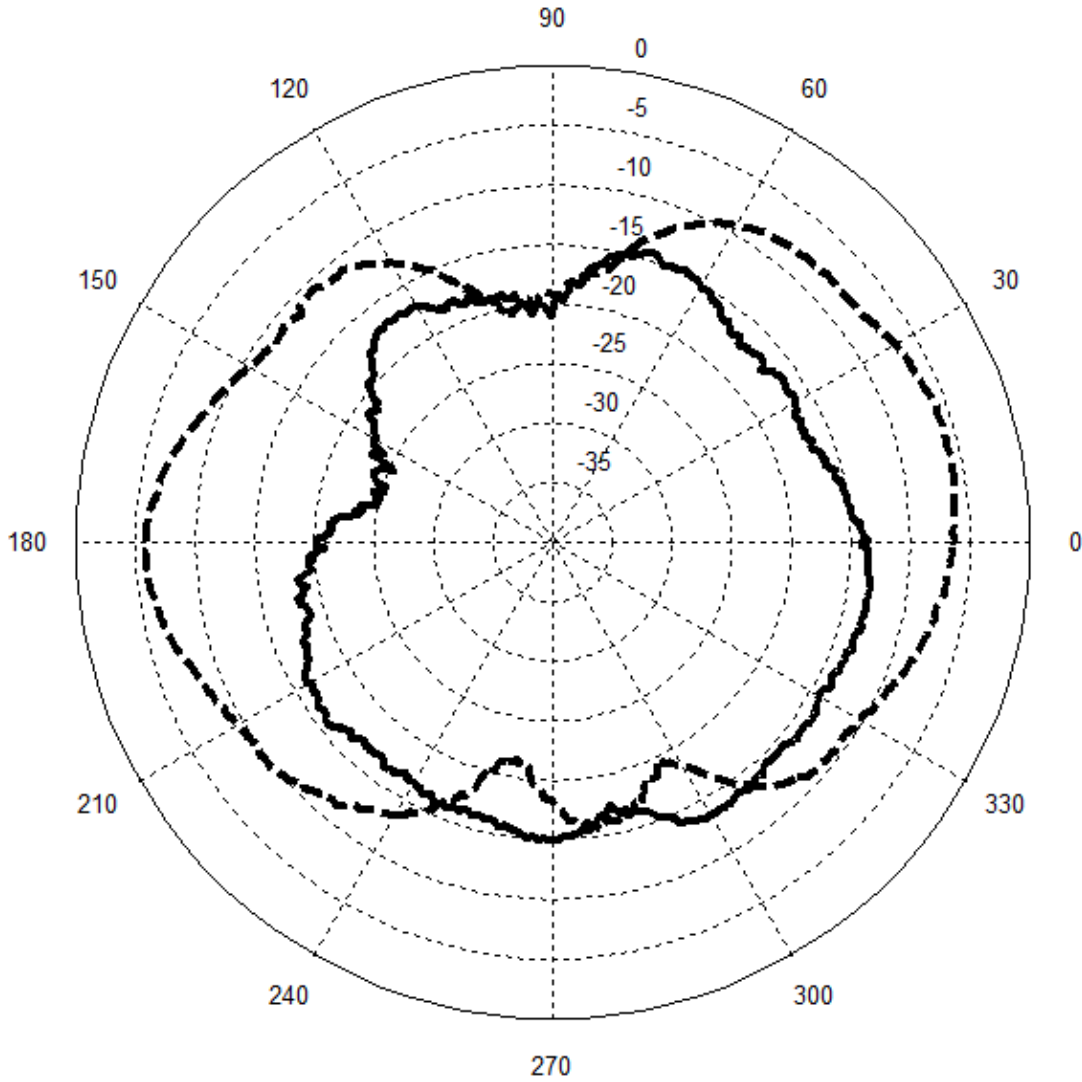

Figure 13 PCB Trace Antenna Pattern (Horizontal @ 2440 MHz)



_____ Vertical Polarization Gain (dBi) min: -36.0 max: -14.9 avg: -20.0
 - - - - - Horizontal Polarization Gain (dBi) min: -18.7 max: -6.7 avg: -10.1

Figure 14 PCB Trace Antenna Pattern (Flat @ 2440 MHz)



— Vertical Polarization Gain (dBi)	min: -25.4	max: -13.0	avg: -16.2
- - - Horizontal Polarization Gain (dBi)	min: -21.5	max: -5.8	avg: -9.7

Figure 15 PCB Trace Antenna Pattern (Vertical @ 2480 MHz)

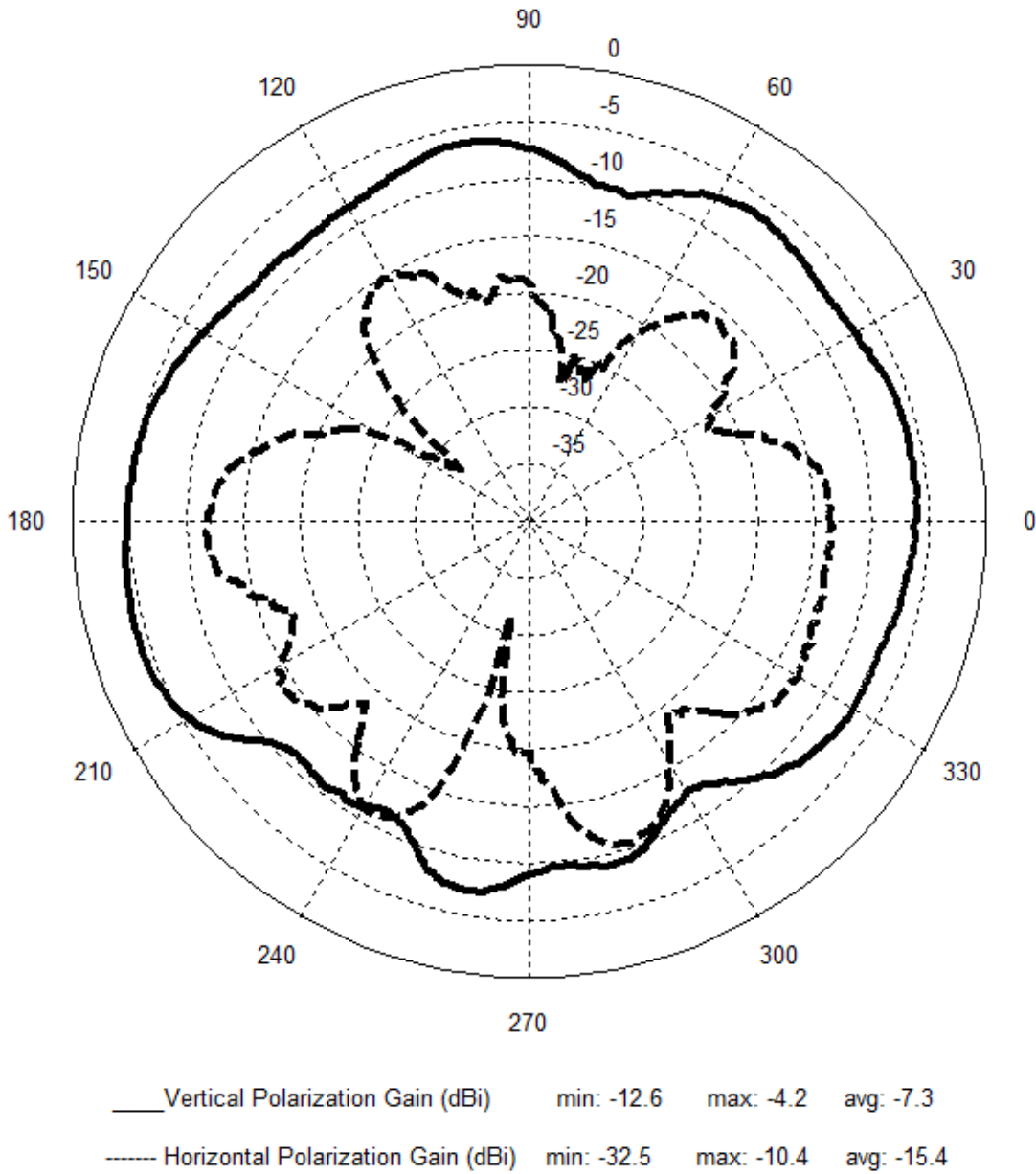
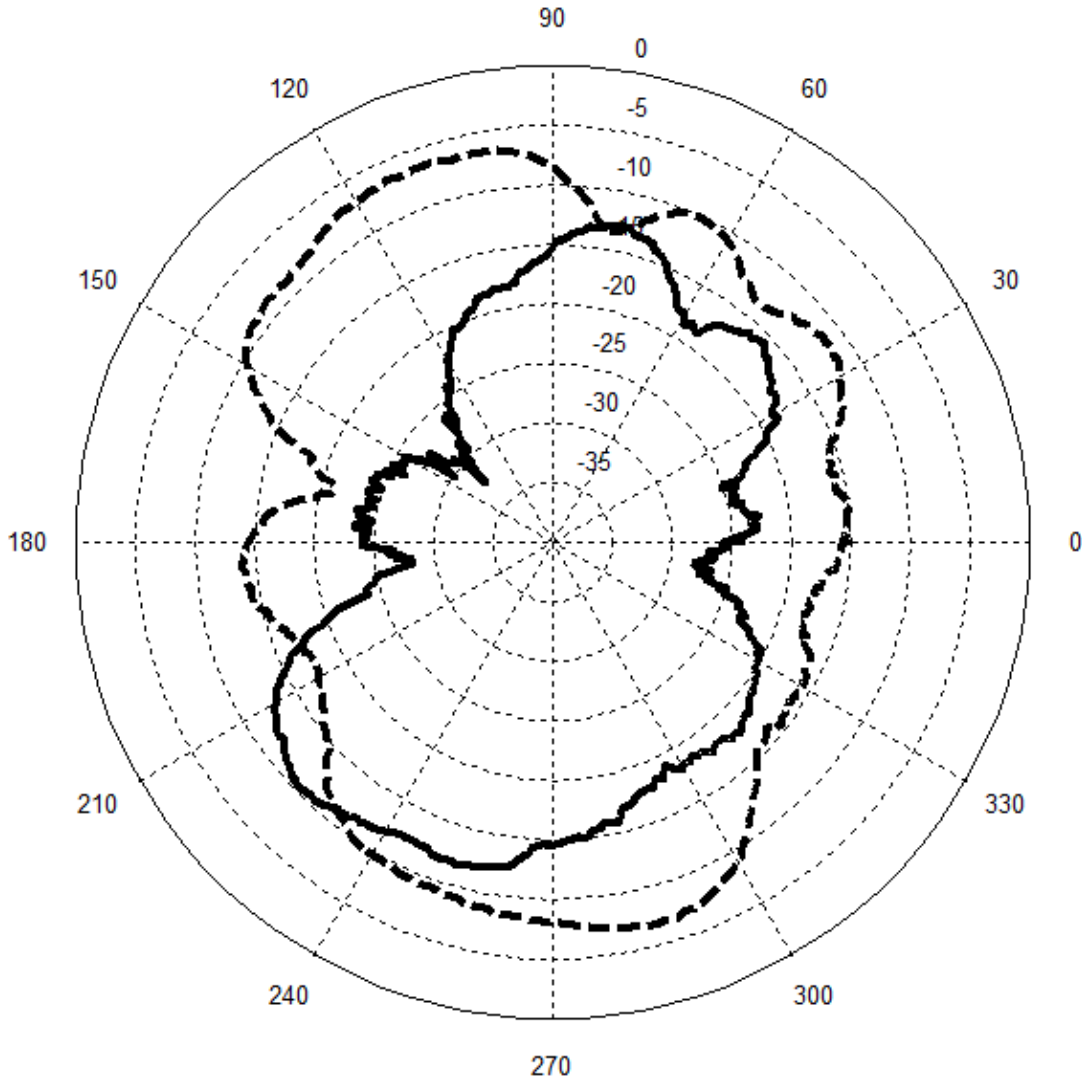

Figure 16 PCB Trace Antenna Pattern (Horizontal @ 2480 MHz)



_____ Vertical Polarization Gain (dBi)	min: -32.5	max: -10.4	avg: -16.6
----- Horizontal Polarization Gain (dBi)	min: -21.2	max: -6.6	avg: -10.8

Figure 17 PCB Trace Antenna Pattern (Flat @ 2480 MHz)

MECHANICAL DATA

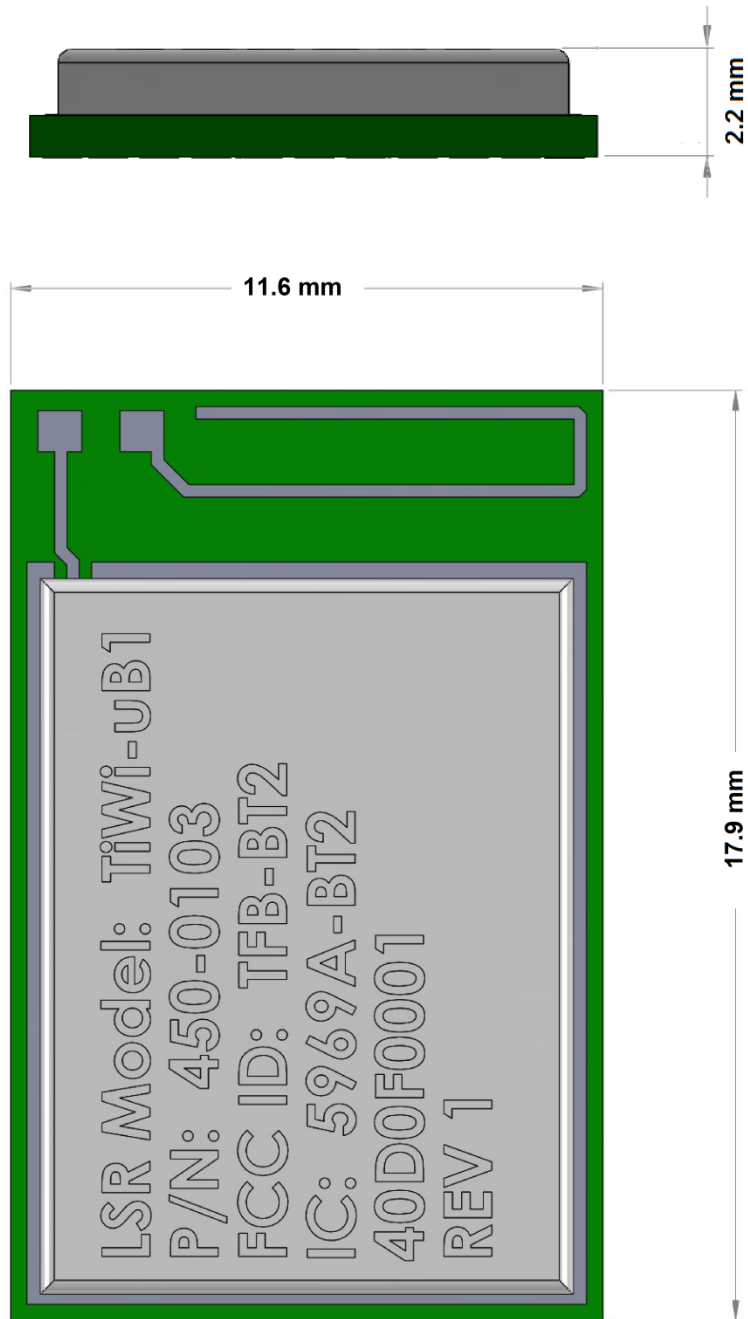

Figure 18 Module Mechanical Dimensions (Maximum Module Height = 2.3mm)

PCB FOOTPRINT

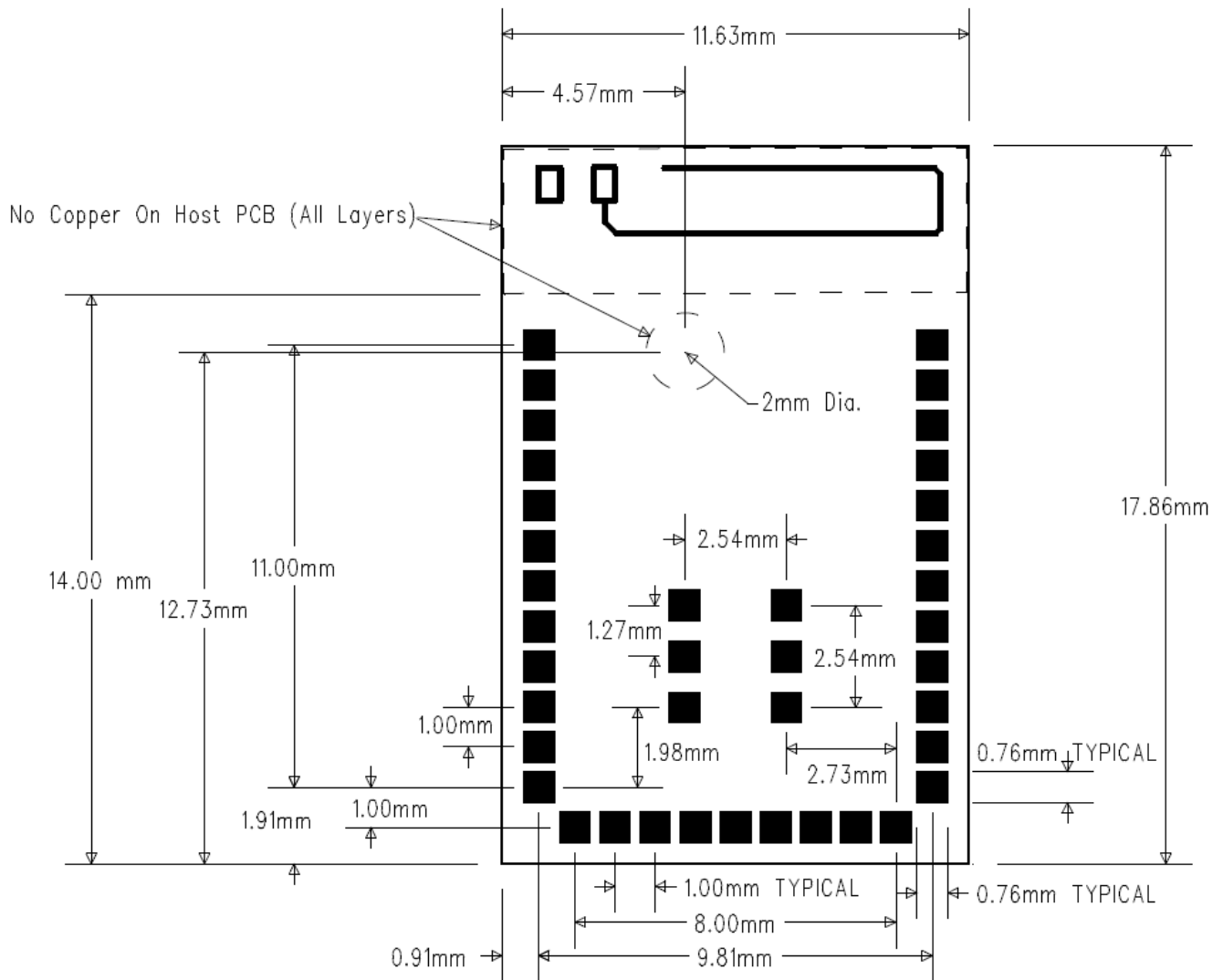
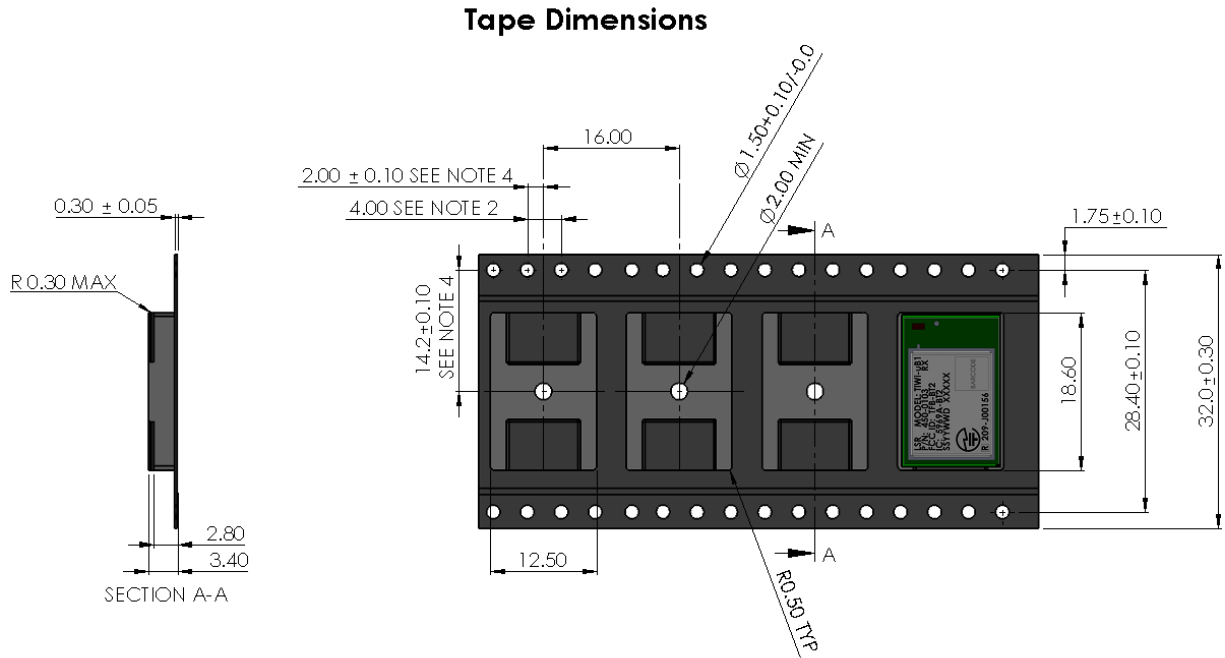

Figure 19 TiWi-uB1 Recommended PCB Footprint (Viewed from Top)

Tape & Reel Dimensions



- NOTES:
1. DIM in mm.
 2. 10 Sprocket Hole Pitch Cumulative Tolerance ± 0.2 mm.
 3. Camber in Compliance with EIA 481.
 4. Pocket Position Relative to Sprocket Hole Measured as True Position of Pocket, not Pocket Hole
 5. A Full Reel contains 1000 Modules

(Module Must Be in this Orientation when Feeding Tape)

Figure 20 Tape and Reel Specification

DEVICE MARKINGS

Rev 1 Devices

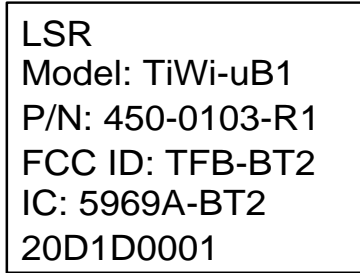

The shield on the 450-0103 / 450-0106 modules contains the following information:

- LSR Model: TiWi-uB1
- Part Number and Revision:
 - Part Number: 450-0103 or 450-0106
 - Revision: -RX (where X is the latest revision)
- FCC ID: TFB-BT2
- IC: 5969A-BT2
- Manufacturer Information

Rev 2 Devices

- Updated the label to include Giteki EMC marking information.
- Updated the label to include a date code.

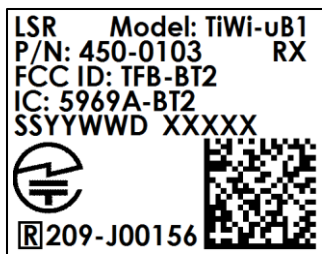

Where RX = Revision X
SSYYWWD = Date Code (YY=Year, WW=Week)
XXXXX = Incremental Serial Number
2D Barcode Format is Data Matrix Standard

CONTACTING LSR**Headquarters**

LSR
W66 N220 Commerce Court
Cedarburg, WI 53012-2636
USA
Tel: 1(262) 375-4400
Fax: 1(262) 375-4248

Website

www.lsr.com

Sales Contact

sales@lsr.com

The information in this document is provided in connection with LS Research (hereafter referred to as “LSR”) products. No license, express or implied, by estoppel or otherwise, to any intellectual property right is granted by this document or in connection with the sale of LSR products. EXCEPT AS SET FORTH IN LSR’S TERMS AND CONDITIONS OF SALE LOCATED ON LSR’S WEB SITE, LSR ASSUMES NO LIABILITY WHATSOEVER AND DISCLAIMS ANY EXPRESS, IMPLIED OR STATUTORY WARRANTY RELATING TO ITS PRODUCTS INCLUDING, BUT NOT LIMITED TO, THE IMPLIED WARRANTY OF MERCHANTABILITY, FITNESS FOR A PARTICULAR PURPOSE, OR NON-INFRINGEMENT. IN NO EVENT SHALL LSR BE LIABLE FOR ANY DIRECT, INDIRECT, CONSEQUENTIAL, PUNITIVE, SPECIAL OR INCIDENTAL DAMAGES (INCLUDING, WITHOUT LIMITATION, DAMAGES FOR LOSS OF PROFITS, BUSINESS INTERRUPTION, OR LOSS OF INFORMATION) ARISING OUT OF THE USE OR INABILITY TO USE THIS DOCUMENT, EVEN IF LSR HAS BEEN ADVISED OF THE POSSIBILITY OF SUCH DAMAGES. LSR makes no representations or warranties with respect to the accuracy or completeness of the contents of this document and reserves the right to make changes to specifications and product descriptions at any time without notice. LSR does not make any commitment to update the information contained herein. Unless specifically provided otherwise, LSR products are not suitable for, and shall not be used in, automotive applications. LSR’s products are not intended, authorized, or warranted for use as components in applications intended to support or sustain life.

The information in this document is subject to change without notice.